

Installation notes:

Faucet and silicone are not included.
 All sizes are subject to tolerance.

Sink assembly

Install the faucet to the top and drains to the sink. Refer to the faucet and drain manufacturer's instructions. Complete the faucet connections. Run water and check for leaks. Apply a bead of silicone behind the top surface to the finished wall.

RESIN BASIN ART. 50262

Top view of sink

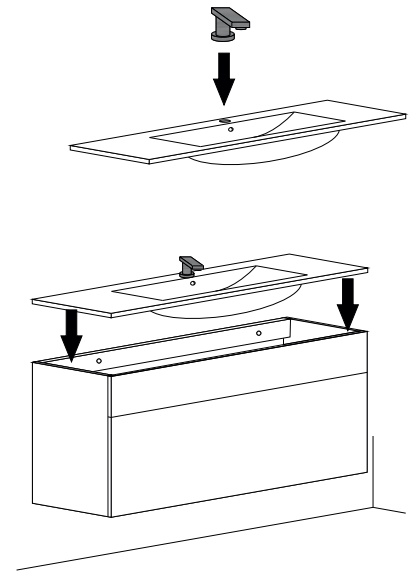
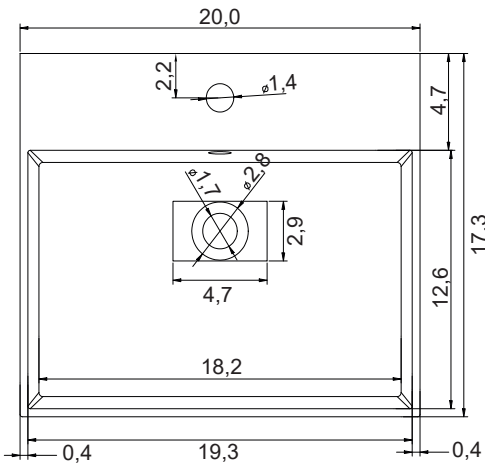
RESIN BASIN ART. 50263

Top view of sink

